



MODEL : PGN700FCA-BK

700W SMART POWER GENERATOR

DIRECT AC RE-CHARGE - 80% IN 1 HOUR

Product Description

This manual applies to the relevant characteristics of the **POWEROLOGY 700W SMART POWER GENERATOR** and is the basis for product design, production and inspection. The design system consists of a ternary lithium 851P battery protection board, PD circuit, DC charging circuit, MCU control circuit, bi-directional inverter circuit and LCD screen. Inverter 700W pure sine wave AC110V/(220V)/50Hz/60Hz,DC12V/10A,USB QC3.0, TYPE-C PD3.0. suitable for camping, emergency communication, medical rescue, fire rescue etc.



TOP



LEFT



BACK



FRONT



RIGHT

SIZE

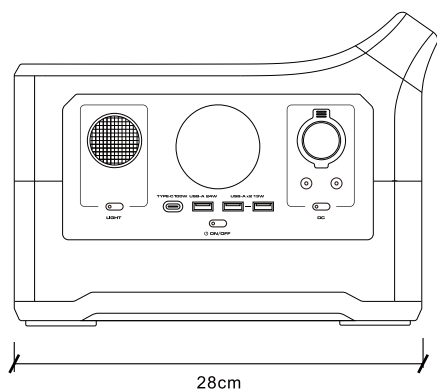

28cm

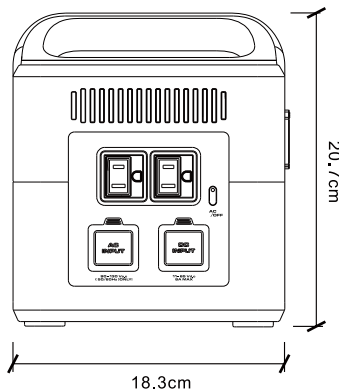

18.3cm

20.7cm

700W
MAX POWER & 12000mAh
POWER STATION

Product specifications

Model	PGN700FCA-BK
Capacity	15000mAh*8 strings 1 parallel 120000mAh
Products Size	28cmx18.3cmx20.7 cm
G.W / N.G	
Cell	LiFePO4/15000mAh
AC Power	Sine wave AC 700W 110V 60Hz
AC Peak Value	1100W
Conversion Efficiency	>90% full load

Product Specifications



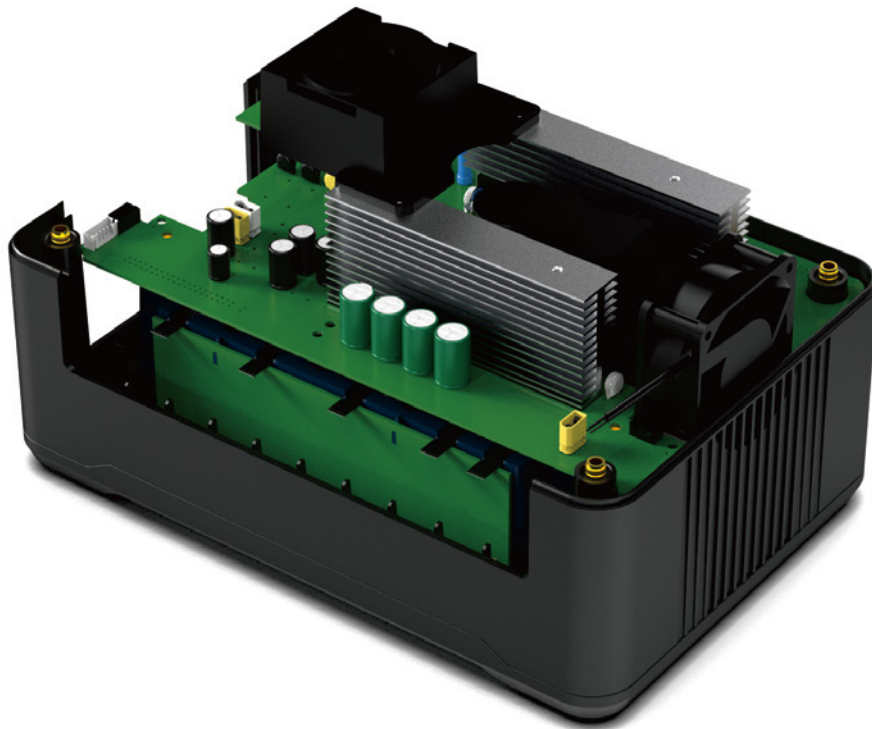

Category	Projects	Specifications
INPUT	DC input	Anderson 10-45V 200W MAX
	AC input	110V/60HZ 300W MAX
AC OUT	AC output voltage	2 AC sockets 110V±5%
	AC output power	Rated 700W
	AC output waveform	Pure sine wave
	Peak AC output	1100W peak sustain time <300ms
	Frequency	50Hz/60Hz
USB output	USB-A-1 *2 outputs	5V 13W MAX
	USB-A-2 *1 output	5V/9V12V 24W MAX
	USB-C*2 output	5V/9V/12V/15V/20V 100W MAX
DC12V output	DC5521*2 output	13.6V/3A
	DC car charger output	13.6V/10A
Electric cores	Type	LiFePO4/15000mAh
	Capacity	120000mAh
	Number of cycles	3000次
Charging time	DC	DC≤2小时 200W MAX
	AC	Fast charging ≤ 1.6 hours, slow charging ≤ 5 hours
Screen display information	USB, TYPE-C, DC status (active status icon lit)	Switch controlled by keypad
	AC IN, AC OUT, SOLAR status (active status icon lit)	AC OUT is switched by key control; AC IN, SOLAR are automatically controlled by input detection
	Remaining capacity SOC	Percentage, 10 cell power column (10% per cell)
	Time remaining	Minimum display in minutes, maximum display 99 hours
	Warning Message	Over temperature,  overload
	Fan status	Rotate, stop
Power-on static power consumption		
Over temperature protection	Over temperature protection	PD 105°C, inverter 95°C
	Overtemperature recovery	Inverter 80°C
Over temperature protection	Discharge	-20°C~60°C±3°C
	Charging	0°C~45°C±3°C



Lithium iron phosphate protection plate battery characteristics

Projects	Parameter symbols	Details	Standard values
Overcharge protection	VCU	Overcharge detection voltage	3.65V
	VCL	Overcharge release voltage	3.55V
Over-discharge protection	VDL	Over-discharge detection voltage	2.70V
	VDR	Over-discharge discharge voltage	3.0V
		Overcurrent protection / overload protection	53A
		Protection release conditions	Disconnecting the load
Over temperature protection		Charging over-temperature protection	50°C
		Charge over temperature recovery	45°C
		Discharge over-temperature protection	60°C
		Discharge overtemperature recovery	55°C
Short circuit protection		Short circuit protection conditions	Short circuit in external circuit
		Short circuit protection release conditions	Disconnecting short-circuit loads
Current consumption	IDD	Internal circuit consumption during operation	150mA

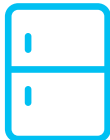
Product discharge time

Digital camera 16Wh	Drones 45Wh	Mobile phone charging 10Wh	Refrigerator 60W
29+ times 	7+ times 	35 times 	7 hours 
Camping light 10W	Ventilator 40W		
45+ hours 	6 hours 		

Product reliability testing

Serial number	Test items	Inspection standards	Test results
1	Constant temperature and humidity testing	Put the fully charged power supply into a temperature-controlled box at 40°C±5°C and relative humidity of 90%-95% for 12 hours, and after removing it, place it at an ambient temperature of 25°C±5°C for 2 hours and then test the performance of the product. The performance of the product is then tested.	OK
2	High temperature test (discharge)	Place the fully charged power supply into a high temperature chamber at an experimental temperature of 55°C ± 5°C for 2 hours and then remove it. Place in ambient temperature of 25°C±5°C for 2 hours and then test the performance of the product.	OK
3	Low temperature test (discharge)	Put the fully charged power supply into the experimental temperature -10°C±5°C cryostat, place it for 2 hours and then remove it in ambient temperature of 25°C±5°C for 2 hours and then test the performance of the product.	OK
4	High temperature test (charging)	Place the discharged power supply in a high temperature chamber at 40°C±5°C for 2 hours and then remove it. at an ambient temperature of 25°C±5°C for 2 hours and then measure the performance of the product. test.	OK
5	Low temperature test (charging)	Put the discharged power supply into the experimental temperature -10°C±5°C cryostat, place it for 2 hours and then remove it in ambient temperature of 25°C±5°C for 2 hours and then test the performance of the product.	OK
6	Vibration testing	Harmonic vibration at a frequency of 100Hz for not less than 10 minutes for 10 minutes, followed by experiments Testing of product performance.	OK
7	(Drop test (box)	The product was dropped from 0.5m height onto a hardwood board with a thickness of 18-20mm (X, Y, Z 6 directions respectively), the shell does not crack, and then the product performance is measured after the experiment. After the test, the performance of the product will be tested.	OK
8	ESD Testing	Contact discharge: 3KV for 10 seconds 1 time every 1 second for 10 seconds, then test the product performance after the experiment.	OK



B



A



C



D



E



F



G

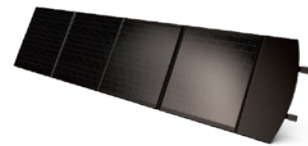

H

Continuous updates ...

List of standard equipment

No.	Specification	Number	Material Code
A	Portable Power Station	1PCS	
B	Colour box inside	1PCS	
C	1.0 m AC charging cable (input)	1PCS	E100930019
D	1.0 m car charger input cable (input)	1PCS	E100930016
E	User manuals & warranty cards	1PCS	

List of options (available at the relevant 3E website)

No.	Specification	Number	Material Code
F	Solar charging cable (MC4 to Anderson port input)	1PCS	E100920005
G	Car battery charging cable (output)	1PCS	E100920004
H	Solar panels	1PCS	E500130001



Product Function Description

No.	Interface buttons	Details
(1)	Switch buttons	Turn on the mobile power station by flicking the switch. When the Mobile Power Station is switched on, the display lights up at the same time; in the power-on state Press the power button briefly to switch on or off the USB, TYPE-C and cordless charging functions, and press and hold the power button for 2 seconds to switch off the power
(2)	Illuminated light/ IOT control switches	(6) lights up in a cool white light; when the key is pressed again, (6) flashes with the "SOS frequency" and the ☐ icon lights up; When the key is pressed again, the switch is switched off (OFF), the light goes out and (6) stops working; When the key is cycled off (OFF) in this way; When the switch is pressed and held down, the IOT turns on, the ☐ icon lights up and the phone can be connected to the Power Generator.
(3)	USB-A interface	Stand alone support 5V/2.5A, output support up to 13W
(4)	USB-A interface	Supports QC3.0 protocol, supports 5V/3A, 9V/2A, 12V/1.5A for standalone use, output supports up to 24W
(5)	USB-C interface	Support PD protocol, 5V/3A, 9V/3A, 12V/3A, 15V/3A, 20V/3A, max output 100W
(6)	LED lighting	Warm White, Cool White, SOS (5W)
(7)	Car charger with DC 5521 interface Output control switch	When turned on (ON), the indicator lights up (8) and (9) start working and the Ⓜ icon lights up, when connected to the device (8) shows the total output power in real time; when turned off (OFF), the indicator lights go off, (8) and (9) stop working and the Ⓜ icon lights up. The total output power is displayed in real time when the device is connected; when OFF, the indicator light goes off, (8) and (9) stop working and the Ⓜ icon goes out
(8)	DC5521 interface	Supports 13.6V/3A output
(9)	Car charger interface	Supports 13.6V/10A output
(10)	Wireless chargers	Supports 15W wireless fast charging



Product Function Description

No.	Interface buttons	Details
I	AC output control switch	When ON, the indicator light is on, I starts working and the Ⓢ icon is on, when the device is connected Ⓢ shows the total output power in real time; when OFF, the indicator light is off, I stops working and the Ⓢ icon is off. When the device is connected, the total output power is displayed in real time; when it is turned off, the indicator light goes off, I stops working and the Ⓢ icon goes off
II	AC110V*2 output interface	Rated output 700W
III	Anderson Interface	Supports 10-45V 200W MAX DC charging
IV	AC charging port	Connects to the grid via the AC connection cable included with the main unit, supports 100-120V/60Hz300W MAX charging



Product Function Description

No.	Display panels	Details
①	USB-C interface status indication	Switch control via ("Interface keys" in (2))
②	DC interface status indication	Switch control via ("interface keys" in (6))
③	USB-A interface status indication	Switch control via ("Interface keys" in (2))
④	AC OUT interface status indication	Switch control via ("Interface key" in 1)
⑤	AC IN interface status indication	The icon lights up when the IV is connected with electricity and goes out when it is disconnected
⑥	Anderson interface charging status indication	When III is connected with power, the icon lights up and ⑦ shows the charging power
⑦	Total input power display	Real-time power display when charging the Power Generator.
⑧	Total output power display	Total output power display
⑨	Ring power indicator ring	Ring-shaped power display with 10 cells, one cell represents 10% of the battery
⑩	Fan status display	Icon lights up when the fan is operating and goes out when the fan is off

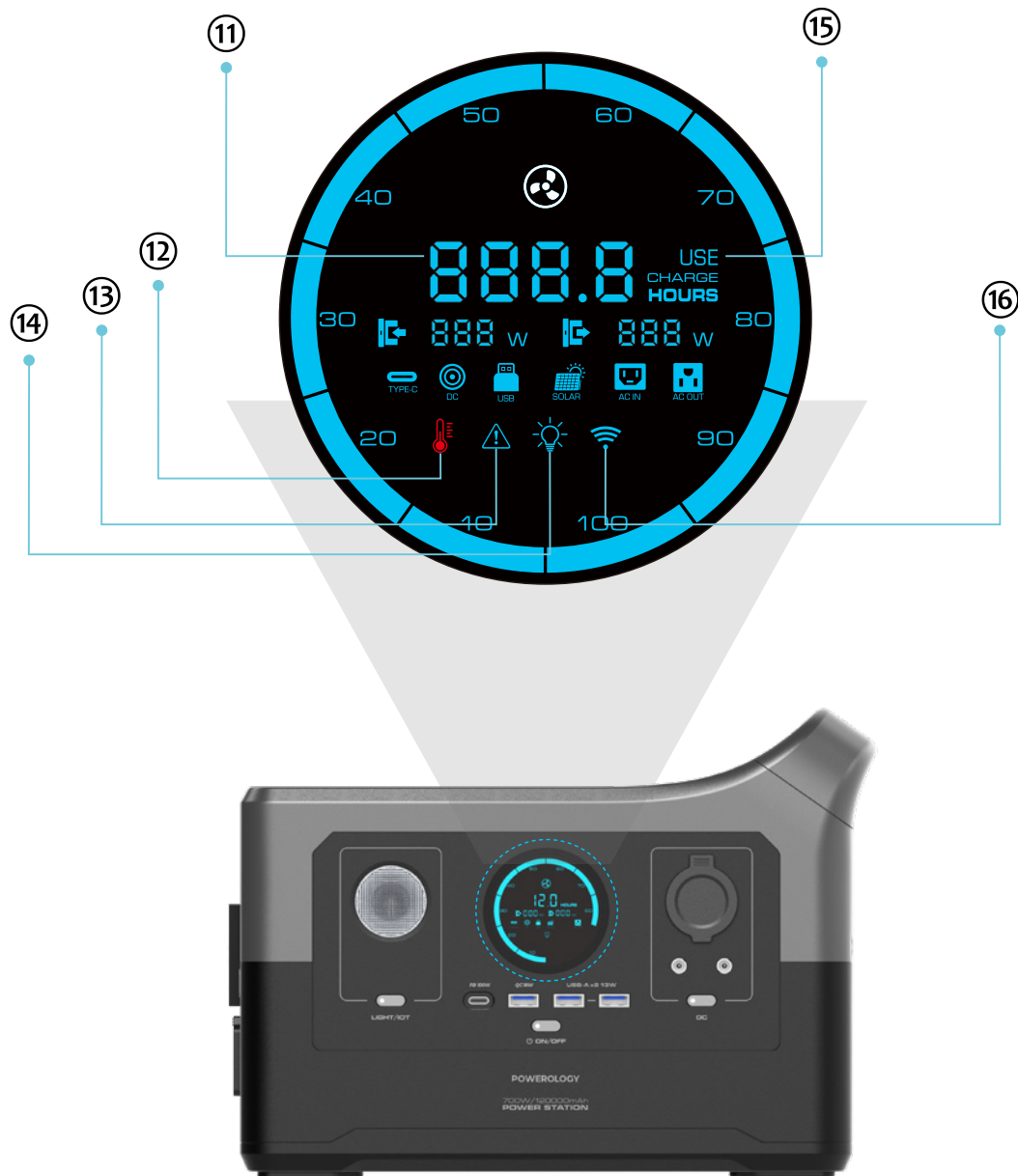

Product Function Description

No.	Display panels	Details
⑪	Percentage of power display	Each cell represents 10% of the charge
⑫	temperature alarm	When the overtemperature is triggered the icon flashes for 10 seconds, the switches off all outputs and when the temperature returns to normal Resume output
⑬	Overload warning icon	Icon illuminates when the access device of Generator is overloaded or short-circuited
⑭	LED lighting icon	Icon lights up when the Generator's LED illumination is switched on
⑮	Remaining time and usage status display	When charging, the digit represents the time required to fully charge, with the minimum display unit being minutes and the maximum display unit being hours; When discharging, with "USE", the number represents the time left to discharge, the minimum display unit is minutes, the maximum display unit is hours. Maximum display unit is hours
⑯	IOT icon	The IOT turns on when the switch is pressed and held down (6), Icon illuminated, phone can connect to Power Generator .

hey@powerology.me | www.powerology.me

 powerology  powerology.me

Made in China

