

# LePRESSO



**LePresso 1.2L 10 Cup Grinding Coffee Machine with Warming Base BS plug**

**SKU: LP10GCMWB**

# Table of Contents

<b>Safety Guidelines</b> .....	<b>2</b>
<b>Features</b> .....	<b>4</b>
<b>Schematic View</b> .....	<b>5</b>
<b>Control Interface</b> .....	<b>6</b>
<b>Specifications</b> .....	<b>6</b>
<b>Before First Use</b> .....	<b>7</b>
<b>Operation Guideline</b> .....	<b>7</b>
<b>Cleaning and Maintenance</b> .....	<b>12</b>
<b>Descaling</b> .....	<b>12</b>
<b>Tips</b> .....	<b>13</b>
<b>Warranty</b> .....	<b>14</b>
<b>Contact Us</b> .....	<b>15</b>

Before using the product, please carefully read this User Manual to guarantee correct usage and keep it secure for future reference.

## **Safety Guidelines**

When utilizing electrical appliances, adherence to the following fundamental precautions is essential:

- 1 . Thoroughly review all provided instructions before use.
- 2 . Refrain from using any appliance that presents with a damaged cord or plug or exhibits any malfunction or damage in any form. Should such conditions be observed, promptly return the appliance to an authorized service facility for professional examination, repair, or adjustment.
- 3 . If the power supply cord is found to be damaged, it is crucial that it be replaced solely by the manufacturer, its service agent, or another individual with comparable qualifications to prevent any potential hazard.
- 4 . To prevent fire, electric shock, or injury, do not immerse the cord, plug, or appliance itself in water or any other liquids.
- 5 . This appliance is not designed for operation by children. Always keep the appliance and its cord out of children's reach.
- 6 . Disconnect the appliance from the power source when not in use and before disassembling, as well as before cleaning. Allow the appliance to cool before attaching or detaching components.
- 7 . Employing accessories not approved by the appliance manufacturer may lead to a risk of fire, electric shock, or injury to individuals.
- 8 . Exercise caution when interacting with the appliance's sharp blades.
- 9 . Keep your fingers at a safe distance from any moving components.

10. Before operation, inspect the grinding chamber to ensure no extraneous objects are present.
11. Incorrect use of the appliance could lead to potential harm.
12. Under no circumstances should the appliance be submerged in any liquid.
13. This appliance is not designed for outdoor use.
14. Prevent the power cord from draping over the edge of the counters or coming into contact with hot surfaces.
15. Avoid placing the appliance near any source of high heat, such as a lit gas or electric burner, or inside an oven.
16. The appliance should be utilized solely for its intended purposes.
17. Do not place a hot container on top of surfaces that are either hot or cold.
18. Ensure that the coffee maker is never operated without water.
19. The container provided is specifically designed for use with this appliance and should not be used on a stovetop.
20. Refrain from cleaning the container with harsh cleansers, steel wool pads, or other abrasive materials.
21. To disconnect the appliance, first set any controls to the "Off" position, then remove the plug from the wall outlet by grasping the plug itself. Never pull on the cord to disconnect.
22. Opening the water tank lid while brewing may result in scalding due to steam. Exercise caution to avoid steam burns.
23. As certain parts of the appliance become hot during use, avoid

direct contact with hands. Use the knobs or handles provided.

**24.** Do not use the appliance if the container is cracked or the handle is loose or compromised, as it may be fragile and could result in injury or breakage. The jug should only be used in conjunction with this appliance.

**25.** Supervision of children is necessary to prevent them from playing with the appliance.

**26.** Individuals with reduced physical, sensory, or mental capabilities, or lack of experience and knowledge, may operate the appliance provided they are under supervision or have been instructed on how to use it safely and understand the associated risks.

**27.** The intended use of this appliance encompasses household and comparable settings, which include:

**A.** Staff kitchen areas within retail shops, offices, and other professional spaces.

**B.** Farmhouses.

**C.** Accommodations in hotels, motels, and other residential establishments.

**D.** Bed and breakfast venues and similar hospitality environments.

**28.** This appliance features a grounded plug for safety. Confirm that the wall outlet in your home is properly grounded.

**29.** Retain these instructions for future reference.

## **Features**

**1 .** Horizontal grinding system: Offers ease of assembly and enhanced stability.

**2 .** Direct-drop structure: Minimizes residual coffee powder.

**3 .** Removable water tank: Designed for hassle-free water refilling and easy cleaning.

4 . Adjustable settings: Allows customization of coffee granule size and strength to preference.

5 . Efficient brewing: Delivers quick brewing times without compromising quality.

## Schematic View

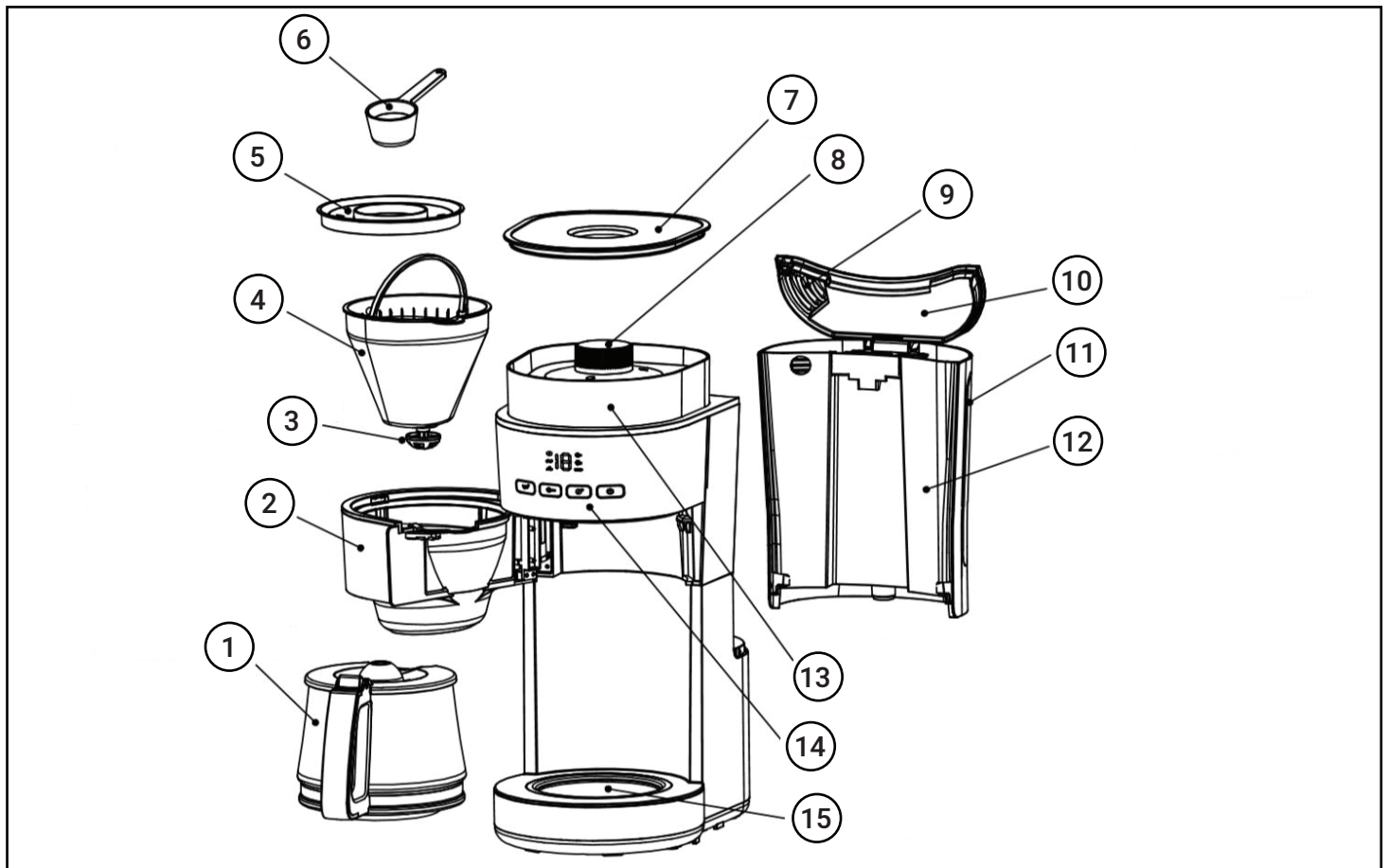

1 . Glass Carafe  
2 . Funnel Holder  
3 . Anti-drip Valve

4 . Funnel  
5 . Funnel Cover  
6 . Coffee Spoon  
7 . Bean Box Lid  
8 . Grind Control Knob

9 . Vent  
10. Water Tank Lid  
11. Water Level Gauge  
12. Water Tank  
13. Bean Box  
14. Control Panel  
15. Warming plate

## Control Interface

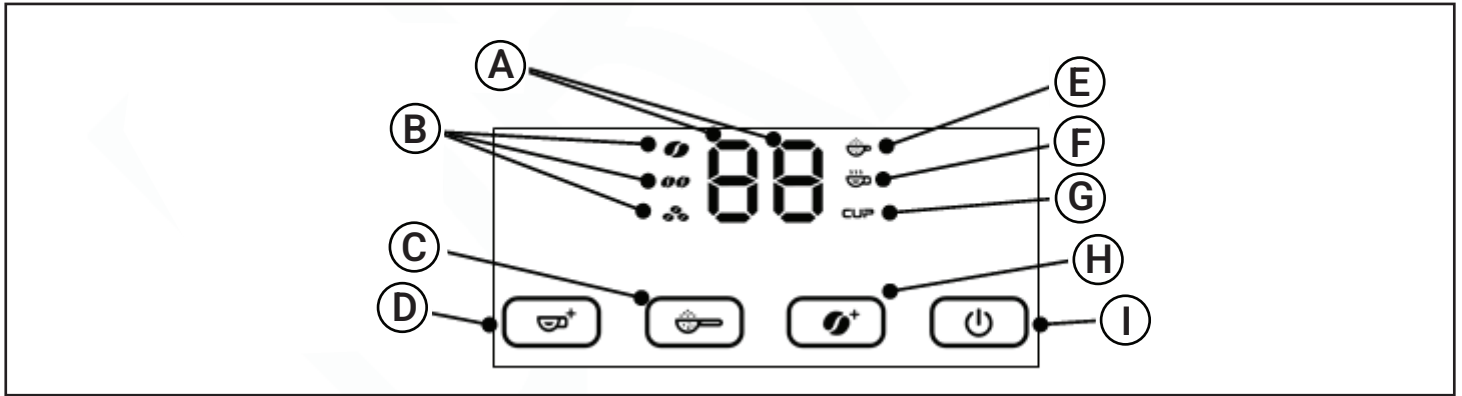

- A. Displays cup numbers: 10 ,8 ,6 ,4 ,2
- B. Concentration indicator icon. From top to bottom: light, medium, dense.
- C. Bean powder key
- D. Cup volume button

- E. Bean powder key icon
- F. Active program indicator
- G. Cup size icon
- H. Concentration Key
- I . ON/OFF key

## Specifications

Model	LP10GCMWB
Output Capacity	10 Cups (1250ml)
Operating Voltage	220-240V ~ 50-60Hz
Power	1000W
Water Tank Capacity	1.25L
Bean Box Capacity	160-250gr
Coffee Temperature	78°C ± 2°C
Dimensions	435×190×300mm
Net Weight	12.22kg

## Before First Use

Ensure that all accessories are accounted for and that the unit is intact and undamaged. Fill the water tank to the maximum level and proceed to cycle water through the machine multiple times without the addition of coffee powder, then dispose of the water. Thoroughly clean all removable components, such as the funnel cover and funnel, using warm water.

## Operation Guideline

### 1 . Brew coffee using coffee powder

1.1 Lift the lid of the water tank and pour the required volume of water into it. For instance, if you desire 2 cups of coffee, fill the tank to the level marked "2". Once filled, secure the water tank lid.

**Note:** Avoid filling the water tank beyond the maximum level as marked on the tank. The appliance is capable of brewing a maximum of 10 cups of coffee per cycle.

1.2 Open the funnel holder, then place the funnel, paper filter, and funnel cover into it in that order. Ensure that the funnel, paper filter, and funnel cover are properly fitted in place.

1.3 Dispense the appropriate amount of coffee powder into the paper filter. Generally, one level spoon of coffee powder is recommended per cup, but this can be adjusted to suit your taste preferences. After adding the coffee, secure the funnel holder.







**Note:** A level spoon of coffee powder is about 7-5gr.



Coffee amount (cup)	Coffee powder amount/ A level spoon (spoon)	Water amount/Scale
2	2	2
4	4	4
6	6	6
8	8	8
10	10	10

**Note:** Ensure that the funnel holder is securely fastened in place. If it is not correctly positioned, the glass carafe will not sit properly on the warming plate, potentially affecting the quality of the coffee brewing process.

**1.4** Position the glass carafe on the warming plate by following these steps: first, align the spout of the glass carafe with the anti-drip valve. Then, slide the carafe forward so that the center line of the carafe corresponds with the anti-drip valve. Make sure that the glass carafe is positioned accurately.

**1.5** Connect the appliance to the power source. All indicators will illuminate for 2 seconds, and the buzzer will emit an audible sound once. Then, the three indicators for , , and  remain on, indicating that the device is in standby mode. To begin the operation: first press  to select the grinding option and then press . The appliance will start to work. At this time, the  indicator will turn off, the  indicator and the light bar will blink, and the other indicators will turn off.

**Caution:** Never open the funnel holder during operation to avoid the risk of being scalded.

**1.6** After brewing, coffee will flow into the glass carafe from the outlet. A single “beep” sound is emitted, and the appliance will switch to the keep-warm condition. At this time, the  indicator and the **LIGHT** indicator will turn off, while the light bar will emit a steady light. After maintaining the warm condition for about 35 minutes, three “beeps” are emitted, indicating the keep-warm task period has ended, and all indicators and the light bar will turn off.

**1.7** Press **ON/OFF** again if you wish to stop the appliance during brewing. This action will place the appliance in standby mode: To resume operation, simply press **ON/OFF** once more.

**Caution:** To avoid the risk of scalding, do not touch the vent of the water tank during brewing. For the best flavor, serve the coffee immediately after brewing.

**Note:** The amount of coffee produced will be less than the volume of water you added, as some water is absorbed by the coffee grounds.

**Caution:** When pouring coffee, ensure that the glass carafe is inclined no more than a 45-degree angle from the vertical position. Pour the coffee slowly until the carafe is empty to prevent the coffee from rushing to the bottom of the carafe lid, potentially causing the coffee to flow out from the edges of the lid and cause injury.

**1.8** Always turn the coffee maker off and unplug the appliance when it is not in use.

## **2 . Brew coffee using coffee beans**

**2.1** Lift the lid of the water tank and pour in the desired amount of water. For example, to prepare 2 cups of coffee, fill the water tank to the level marked "2". Afterward, securely close the water tank lid.

**Note:** Ensure the water level does not surpass the maximum indicator on the water tank. The device is capable of brewing up to 10 cups of coffee in a single cycle.



2.2 Open the funnel holder, then sequentially place the funnel, paper filter, and funnel cover into the designated area. Confirm that the funnel, paper filter, and funnel cover are securely installed.

**Note:** The funnel holder must be securely closed; otherwise, the glass carafe cannot be correctly seated on the warming plate, affecting the quality of the coffee brewing process.

2.3 Add the appropriate amount of coffee beans into the bean box, then secure the lid of the bean box.

**Note:** The bean box should contain no more than 120 grams of coffee beans.

2.4 Place the glass carafe onto the warming plate. Then, gently slide the carafe forward so that its center line is in alignment with the anti-drip valve. Ensure that the carafe is properly positioned.

2.5 Connect the appliance to the power source. Upon doing so, all indicators will illuminate for 2 seconds and a single audible “beep” sound will be heard, indicating that the appliance is in standby mode with the , , and  indicators remaining illuminated.

2.6 Select the desired cup indicator (10 ,8 ,6 ,4 ,2) corresponding to the number of cups you wish to brew. Enable the grinding option via the touch screen. Turn the knob to adjust the desired grinding setting.

Fine Grind

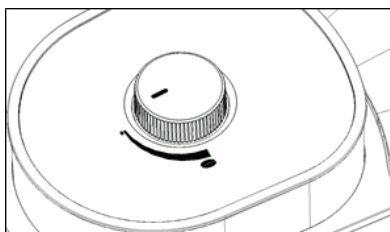

Coarse Grind

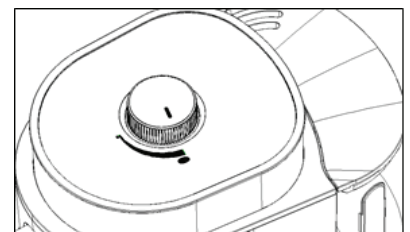

**2.7** Press the **ON/OFF** button to initiate the grinding process. Simultaneously, the **ON/OFF** indicator and the light bar will start to blink.

**2.8** After the appliance finishes grinding, it will begin to brew the coffee. As the coffee starts flowing into the glass carafe from the outlet, the **ON/OFF** indicator and the light bar will blink. Meanwhile, the **2 CUP**, **GRIND OFF**, and **LIGHT** indicators remain illuminated with solid light. A single “beep” signifies that the appliance has switched to the keep-warm mode after the brewing process is complete. As the keep warm mode is activated, the **2 CUP** indicator turns off, and the light bar will remain on with a solid light. The appliance will maintain the coffee at an optimal temperature for about 35 minutes, after which three “beep” sounds are emitted, and all indicators, including the light bar, will turn off.

**Caution:** To prevent burns, do not open the funnel holder while the appliance is in operation.

**2.9** To stop the brewing process while the device is functioning, press the **ON/OFF** button. Upon doing so, the **ON/OFF** indicator turns on with solid light. To resume operation, first ensure the **GRIND OFF** feature is activated, then press the **ON/OFF** button once more to restart the appliance.

**Caution:** Avoid contact with the water tank vent during brewing to prevent burns.

**2.10** Detach the glass carafe to serve once brewing is complete. For the best flavor, it is recommended to serve the coffee immediately after brewing.

**Note:** The volume of coffee produced will be slightly less than the volume of water initially added, as some water is absorbed by the ground coffee beans.

**Caution:** When pouring coffee, ensure that the glass carafe is tilted at

no more than a 45-degree angle from the vertical to prevent the coffee from rushing to the carafe lid's bottom, causing it to potentially flow out and cause injury.

**2.11** Always turn the coffee maker off and unplug the appliance when it is not in use.

## **Cleaning and Maintenance**

**Caution:** Always unplug the appliance before cleaning and ensure it has cooled down completely to avoid the risk of electrical shock. Never immerse the cord, plug, or appliance itself in water or any other liquid.

- 1 . Clean all detachable components such as the funnel cover, funnel, glass carafe, water tank, etc., with warm water. Utilize a small brush after each use.
- 2 . Enable the anti-drip valve by pushing it upwards three to four times to clear any remaining water.
- 3 . Clean the external surface of the product with a soft, damp cloth to eliminate any stains.
- 4 . Clean the warming plate with a damp cloth, avoiding any abrasive cleaners to prevent damage.
- 5 . After cleaning, reassemble all parts in preparation for the next use.

## **Descaling**

To ensure efficient operation of the device, it's crucial to periodically remove the mineral deposits that accumulated from water from the surface of the appliance. The frequency of this maintenance depends

on the water quality in your area and frequency of use.

**We recommend the following steps to perform the descaling task:**

- 1 . Fill the tank with a mixture of water and descaler up to the maximum level indicated on the water tank, using a ratio of 4 parts water to 1 part descaler. Follow the specific instructions provided with your descaler product. If you prefer, you may substitute the descaler with citric acid, using a mixture of 1 part citric acid to 3 parts water.
- 2 . Place the glass carafe onto the warming plate.
- 3 . Ensure that the coffee maker is correctly assembled, that no coffee powder or coffee beans are poured into the device and that the funnel and its cover are in place.
- 4 . Press **GRIND** and then press the **ON/OFF** button to activate the appliance and initiate the descaling cycle.
- 5 . Upon completion of the cleaning cycle, turn the appliance off.
- 6 . Allow the descaling solution to sit in the unit for 15 minutes, then repeat steps 3 to 5.
- 7 . After the final cycle, turn on the appliance to flush the descaling solution through until the water tank is empty.
- 8 . Finally, rinse the appliance by running it with plain water at least three times to ensure all descaling solution is removed.

## **Tips**

- 1 . Maintaining a clean coffee maker is crucial for brewing delicious coffee. Adhere to the cleaning guidelines provided and always use fresh, cold water in the coffee maker.

- 2 . Store any unused coffee powder in a cool, dry environment. Upon opening a package of coffee powder, ensure it is sealed tightly and kept in the refrigerator to preserve its freshness.
- 3 . For the freshest-tasting coffee, purchase whole coffee beans and grind them just before brewing.
- 4 . Avoid reusing coffee powder as it significantly diminishes the coffee's flavor. Additionally, reheating coffee is not advised as the peak flavor is experienced immediately after brewing.
- 5 . Clean the coffee maker if there is any oiliness after brewing, which can occur due to over-extraction. This oiliness is characterized by small oil droplets on the surface of the brewed coffee, resulting from the oils extracted from the coffee powder.

**Note:** The oiliness may be more pronounced when using heavily roasted coffee beans.

## **Warranty**

Products that you buy directly from our **LePresso** website or shop come with a 24-month warranty. The 24-month warranty applies to products purchased directly from our **LePresso** website or store. If **LePresso** products are bought from any of our verified retailers, then the product is eligible for only a 12-month warranty. To extend your product's warranty, visit our website <https://www.lepresso.com/warranty> and fill in your details in the provided form along with an uploaded picture of the product to process your request. Once approved, you will receive a confirmation email of the extended product warranty. Upload the required information within 48 hours of purchase to be eligible for a 24-month warranty period.

For more info, please check:

<https://www.lepresso.com/warranty>

## **Contact Us**

If you have any questions or concerns about our Shipping and Returns Policy, please contact us at:

**info@lepresso.com**

Website: **<https://www.lepresso.com/>**

Instagram: **lepresso\_official**