



LèPRESSO

Lepresso Multifunctional Capsule Coffee
Machine Capsule Storage

SKU: LPMFCMSBK

Important Safety Instructions

Warning: Adherence to basic safety precautions is essential when operating electrical appliances. These include:

1. Thoroughly review this manual before operating the appliance.
2. Verify that the appliance voltage corresponds with your local power supply.
3. To prevent electric shock or fire, never submerge the power cord or plug in water or any other liquid.
4. Ensure supervision when the coffee machine is in use to prevent children or individuals incapable of self-care from being near the appliance.
5. Disconnect the coffee machine from the power source once brewing or cleaning is complete. Allow the machine to cool before disassembling any parts or initiating cleaning procedures.
6. If the power cord or plug is damaged, or if the machine exhibits any other malfunction, cease usage immediately and contact the manufacturer or a service agent for repair.
7. Use only components authorized by the manufacturer to avoid the risk of injury and potential hazards.
8. This appliance is not designed for outdoor use.
9. Prevent the power cord from dangling over the edge of a table or from coming into contact with hot surfaces.
10. Position the coffee machine away from heat sources such as stoves or ovens.

11. The coffee machine is intended exclusively for its designed purpose within a dry environment.

12. Only fill the water tank with cold, clean water. Do not use mineral water, milk, or other liquids.

13. To disconnect the appliance, grasp and pull the plug directly from the outlet. Do not tug on the power cord.

14. Some parts of the coffee machine can become extremely hot during operation. Avoid direct contact with these areas, except for the designated handles.

15. Operate and store the appliance in temperatures above zero degrees Celsius.

16. Avoid using the coffee machine near strong magnetic fields, in high temperatures, or in humid environments.

17. This appliance is not suitable for use by children under the age of 8 years. For older children, usage should only be under adult supervision, and they should be instructed on safe appliance use.

18. If the machine is used by persons with physical, sensory, or mental limitations, or with a lack of experience and knowledge, it should be under the supervision of a person responsible for their safety.

19. Children under 8 years should also not be allowed to touch the appliance or its power cord.

20. This appliance is equipped with a grounding plug. Ensure that your home's electrical socket is grounded before use.

21. Operating the coffee machine with an empty water tank is not allowed.

22. When using the coffee machine for the first time, brew with water only to ensure smooth operation in subsequent uses.

23. To prevent injury, do not insert fingers into the brewing chamber.

24. Since the brewing chamber contains hot water, do not open it during operation to avoid burns.

25. The appliance is designed for both household and commercial use, suitable for environments such as staff kitchen areas in shops, offices, farms, hotels, motels, and other residential as well as accommodation with breakfast services.

Product Specifications

Name: Multifunctional Capsule Coffee Machine Capsule Storage

Model: LPMFCMSBK

Voltage: 220-240V, 50Hz, 1400W

Capacity: Maximum 800ml

Size: 145mm (Width) x 245mm (Height) x 285mm (Length)

Net weight: 2850g

Safety compliance: CB

Product Diagram

- A. Cup capacity indicator light
- B. Button to decrease water volume
- C. Start button
- D. Button to increase water volume
- E. Coffee cup (not included)
- F. Drip Tray
- G. Lid of the water tank

H. Water tank

I. Power button

J. Capsule drawer

K. Stand for capsule holder

L1. Capsules holder lid

L2. Nespresso® capsule holder

M. Holder for Dolce Gusto® capsules

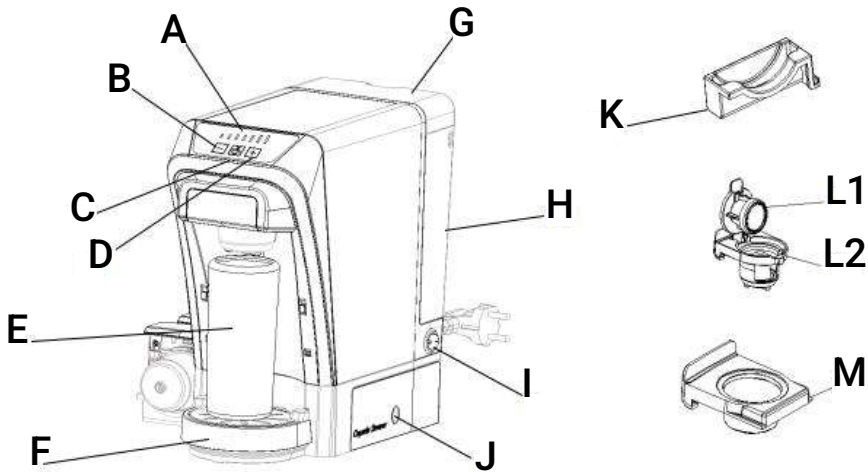

Product Description

This product is meticulously crafted for the sole purpose of brewing coffee and is compatible with Nespresso® and Dolce Gusto® coffee capsules.

Please note that Nespresso® and Dolce Gusto® are trademarks registered to Nestlé S.A., and no affiliation exists between these brands and the manufacturer, distributor, or seller of this product.

Using the Accessories

Using Capsule Holder Stand

1. Locate the three fixed slots on the left lower side of the machine. Insert the capsule holder stand into any of these slots (refer to Pic.1) and ensure the machine is level on the surface.
2. Place the spare capsule holder on the capsule holder stand (illustrated in Pic. 2) to keep it secure and easily accessible.

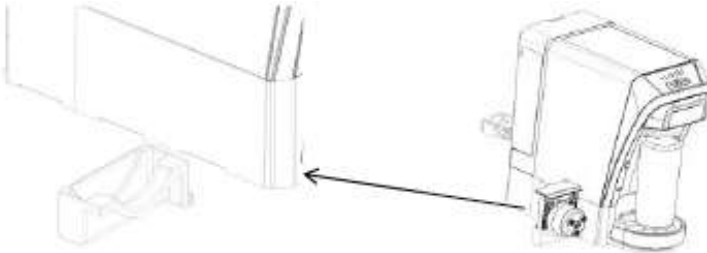

Pic.1

Using Capsule Drawer

To utilize the capsule drawer, press the mechanism to open it (as demonstrated in Pic. 3), insert the desired Nespresso® and Dolce Gusto® capsules as needed (shown in Pic. 4), then close the drawer by pressing it back into place (see Pic.5).



Pic.3





Pic.4



Pic.5

Before the First Use

1. Unpack the Capsule Coffee Machine and remove all packaging materials.
2. Clean the main unit with a moist, clean cloth.
3. Cleanse the removable water tank, drip tray holder, adjustable drip tray, and capsule holders with warm, soapy water; rinse and let them air dry completely.
4. Fill the water tank, position an empty Nespresso® capsule holder inside, place a cup on the drip tray cover, plug in the power cord, and activate the machine by pressing the power button. When the indicator light turns blue, press the  button to reach full water capacity, followed by the  button until the blue light appears again, signaling the commencement of the water pumping and brewing process.
5. Discard the first cup of coffee produced as it is not recommended for consumption.

Caution: The piercing blades in the Nespresso® capsule holder are extremely sharp. Exercise caution during the handling, emptying, and cleaning of the capsule holder.

*Ensure all components are clean and dry prior to assembly.

*Situate the appliance on a stable, dry, and heat-resistant surface.

Operation Instructions

Preparing the Capsule Holder

A. Dolce Gusto® Coffee Capsule or Compatible Capsule

1. Insert the correct coffee capsule into the Dolce Gusto® capsule holder with the convex side facing downwards.

2. Apply pressure to confirm that the capsule is completely inserted and that the top edge of the capsule fits snugly within the Dolce Gusto® capsule holder.

B. Nespresso® Coffee Capsule or Compatible Coffee Capsule

1. Open the lid of the Nespresso® capsule holder.

2. Position the coffee capsule into the underside of the lid with the rounded side facing down.

Caution: The blades inside the Nespresso® capsule holder are exceptionally sharp. Handle with care.

3. Apply pressure to ensure complete insertion of the capsule, with the top fitting snugly against the holder.

4. Securely close the lid.

C. Brewing Coffee

1. Fill the removable water tank to the appropriate level, ensuring it does not surpass the maximum indicator (800 ml).



2. Connect to power, switch the machine to the 'ON' position, and observe as the button's indicator light turns blue and begins to flash, indicating the heating phase.





3. Position a cup on the drip tray cover, adjusting the tray to the cup's height. Ensure the cup is centered below the coffee outlet (as illustrated in Pic.6).



Pic.6

4. Insert the capsule into the designated holder and place it in the brewing chamber. Once heating is complete and the light remains steady, adjust the cup size with   and initiate brewing by pressing the corresponding buttons. 

5. During brewing, the indicator light of    will diminish to a smaller bar on the left. To halt brewing prematurely, press the start button again.

6. Once all lights on the button    are illuminated, the brewing cycle is complete. Remove the cup.

Note: It is normal to hear a blowing sound from the machine at this stage, and some residual water may drip into the tray due to pressure release. The machine will automatically enter standby mode after brewing, and will shut off if not used for 15 minutes.

7. Handle the capsule holder with caution post-brewing, as it will be hot. Discard the capsule after a single use to maintain coffee quality.

Warming Tips:

*The coffee button can pause the brewing cycle. Press once to pause and again to resume.

*The machine will automatically enter standby mode after brewing and will turn off if left idle for more than 15 minutes.

*Rinse the water tank before first use or if the machine has not been used for an extended period.

*To avoid milk residue in the holder or brewing chamber, run a cycle with just water after using a milk-based Dolce Gusto® capsule. After brewing milk beverages, eject the used capsule, and perform two water-only brewing cycles for cleaning.

5. Coffee Amount Description for Brewing Size Reference (may vary based on different capsules):

Brewing Size	Water	Nespresso® Capsule	Dolce Gusto® Capsule
1	~50ml	~40ml	~30±6ml
2	~70ml	~60ml	~50±7.5ml
3	~90ml	~80ml	~70±10ml
4	~120ml	~110ml	~100±15ml
5	~150ml	~140ml	~130±16ml
6	~200ml	~190ml	~180±21ml
7	~260ml	~250ml	~240±28ml

*The above data are results from the manufacturer's lab testing with specific capsules and may vary with environmental changes. The water amounts listed are for scenarios where only water is brewed without any capsules in the holder.

Descaling and Cleaning



To ensure optimal performance and longevity of your coffee machine, regular descaling and cleaning are recommended based on local water conditions and frequency of use. The standard interval is every three months or after brewing more than 500 cups of coffee.

1. Mix water with a mild detergent in the water tank to a minimum total volume of 600ml, using a 4:1 water-to-detergent ratio, or use a 3% citric acid solution available at pharmacies.



2. Place a container that can hold more than 800 ml on the drip tray to catch the water during descaling.

3. Connect the power plug without any capsule in the holder

4. Power on the machine, press the  button to start descaling. The indicator will alternate between blue and flashing, signaling to initiate the descaling process

   The light will remain steady blue during the descaling.

5. Once descaling is complete, the machine will automatically switch to the cleaning cycle.

6. Refill the water tank with over 600ml of water and start the cleaning process by pressing the  button. The indicator  will maintain a steady blue light while cleaning.

7. After completing the water cycle, the machine will signal the end of the cleaning process  and enter standby mode.

Note: Capsules should not be used during the descaling and cleaning processes.

To clean the outside of the machine:

1. Disconnect the machine from power and allow it to cool before cleaning.
2. Clean the surface with a soft, damp cloth. Avoid using abrasive cleaners.
3. Remove and wash the drip tray and cover with soapy water. Take care when cleaning near the sharp needle under the machine's lid.

Storage

- *Ensure all parts are thoroughly dry before storage.
- *Store the product in a dry location.
- *Shield the product from direct sunlight.
- *Coil the mains cord loosely during storage. Do not tightly wrap the cord around the product.
- *Keep the product out of children's reach, securely locked away, and store at a temperature between 5°C and 20°C room temperature.

Troubleshooting

Problem	Possible Reason	Solution
The product is not turning on.	The mains cord is not connected to the mains supply.	Connect the mains cord to the mains supply.
Coffee is overflowing from the capsule holders	There is too much water in the water tank.	Do not pour water beyond the "MAX" line of the water tank.
	The capsule and/or capsule holder are not in the correct position.	Ensure the capsule and the capsule holder are positioned correctly.
Coffee is not brewing.	The water tank is empty.	Fill the water tank. Ensure the water level does not exceed the "MAX" line of the tank.
	The thermostat inside of the product needs to cool down completely before you can make another coffee.	Wait for 5 minutes and then attempt to brew coffee again.
The product needs longer time than usual to brew a coffee.	The product needs to be cleaned and/or descaled.	Clean and descale the product.
The blue light of buttons flash (1 second 1 time) 	There is a water shortage in the water tank.	Add water to the water tank, taking care not to surpass the "MAX" line.

Contact Us

If you have any questions or concerns about our Shipping and Returns Policy, please contact us at info@lepresso.com .

Website: lepresso.com

Instagram: [lepresso_official](https://www.instagram.com/lepresso_official)